



■ Features :

- Universal AC input / Full range (up to 305VAC)
- Built-in active PFC function
- High efficiency up to 90%
- Protections: Short circuit / Over current / Over voltage / Over temperature
- Cooling by free air convection
- Fully isolated plastic case
- Fully encapsulated with IP67 level (Note.6)
- Class II power unit, no FG
- Class 2 power unit
- Suitable for LED lighting and moving sign applications
- Compliance to worldwide safety regulations for lighting
- Suitable for dry / damp / wet locations
- 3 years warranty



**SPECIFICATION**

MODEL		LPF-60-12	LPF-60-15	LPF-60-20	LPF-60-24	LPF-60-30	LPF-60-36	LPF-60-42	LPF-60-48	LPF-60-54	
OUTPUT	DC VOLTAGE	12V	15V	20V	24V	30V	36V	42V	48V	54V	
	CONSTANT CURRENT REGION Note.4	7.2 ~ 12V	9 ~ 15V	12 ~ 20V	14.4 ~ 24V	18 ~ 30V	21.6 ~ 36V	25.2 ~ 42V	28.8 ~ 48V	32.4 ~ 54V	
	RATED CURRENT	5A	4A	3A	2.5A	2A	1.67A	1.43A	1.25A	1.12A	
	RATED POWER	60W	60W	60W	60W	60W	60.12W	60.06W	60W	60.48W	
	RIPPLE & NOISE (max.) Note.2	150mVp-p	150mVp-p	150mVp-p	150mVp-p	200mVp-p	250mVp-p	250mVp-p	250mVp-p	350mVp-p	
	VOLTAGE TOLERANCE Note.3	±4.0%	±4.0%	±4.0%	±4.0%	±4.0%	±4.0%	±4.0%	±4.0%	±4.0%	
	LINE REGULATION	±0.5%	±0.5%	±0.5%	±0.5%	±0.5%	±0.5%	±0.5%	±0.5%	±0.5%	
	LOAD REGULATION	±2.0%	±1.5%	±1.0%	±0.5%	±0.5%	±0.5%	±0.5%	±0.5%	±0.5%	
	SETUP, RISE TIME Note.7	1000ms, 80ms / 115VAC at full load 1000ms, 80ms / 230VAC									
HOLD UP TIME (Typ.)	16ms/230VAC		16ms/115VAC at full load								
INPUT	VOLTAGE RANGE Note.5	90 ~ 305VAC		127 ~ 431VDC							
	FREQUENCY RANGE	47 ~ 63Hz									
	POWER FACTOR (Typ.)	PF>0.97/115VAC, PF>0.95/230VAC, PF>0.92/277VAC at full load (Please refer to "Power Factor Characteristic" curve)									
	EFFICIENCY (Typ.)	86%	87%	88%	89%	90%	90%	90%	90%	90%	
	AC CURRENT (Typ.)	0.8A / 115VAC		0.4A / 230VAC		0.32A/277VAC					
	INRUSH CURRENT (Typ.)	COLD START 55A(twidth=270µs measured at 50% Ipeak) at 230VAC									
	LEAKAGE CURRENT	<0.75mA / 240VAC									
PROTECTION	OVER CURRENT Note.4	95 ~ 108% Protection type : Constant current limiting, recovers automatically after fault condition is removed									
	SHORT CIRCUIT	Hiccup mode, recovers automatically after fault condition is removed.									
	OVER VOLTAGE	15 ~ 17V	17.5 ~ 21V	23 ~ 27V	28 ~ 35V	34 ~ 40V	41 ~ 49V	46 ~ 54V	54 ~ 63V	59 ~ 66V	
	OVER TEMPERATURE	90°C±10°C (RTH2) Protection type : Shut down o/p voltage, re-power on to recover									
ENVIRONMENT	WORKING TEMP.	-40 ~ +70°C (Refer to "Derating Curve")									
	WORKING HUMIDITY	20 ~ 95% RH non-condensing									
	STORAGE TEMP., HUMIDITY	-40 ~ +80°C, 10 ~ 95% RH									
	TEMP. COEFFICIENT	±0.03%/°C (0 ~ 50°C)									
	VIBRATION	10 ~ 500Hz, 5G 12min./1cycle, period for 72min. each along X, Y, Z axes									
SAFETY & EMC	SAFETY STANDARDS Note.6	UL8750, CSA C22.2 No. 250.0-08(except for 48V, 54V), EN61347-1, EN61347-2-13 independent, IP67, J61347-1, J61347-2-13 approved ; design refer to UL60950-1, TUV EN60950-1									
	WITHSTAND VOLTAGE	I/P-O/P:3.75KVAC									
	ISOLATION RESISTANCE	I/P-O/P:100M Ohms / 500VDC / 25°C/ 70% RH									
	EMC EMISSION	Compliance to EN55015, EN61000-3-2 Class C (≥60% load) ; EN61000-3-3									
	EMC IMMUNITY	Compliance to EN61000-4-2,3,4,5,6,8,11; EN61547, EN55024, light industry level(surge 2KV), criteria A									
OTHERS	MTBF	440.5Khrs min. MIL-HDBK-217F (25°C)									
	DIMENSION	162.5*43*32mm (L*W*H)									
	PACKING	0.45Kg; 32pcs/15.4Kg/0.93CUFT									
NOTE	<ol style="list-style-type: none"> <li>1. All parameters NOT specially mentioned are measured at 230VAC input, rated load and 25°C of ambient temperature.</li> <li>2. Ripple &amp; noise are measured at 20MHz of bandwidth by using a 12" twisted pair-wire terminated with a 0.1µf &amp; 47µf parallel capacitor.</li> <li>3. Tolerance : includes set up tolerance, line regulation and load regulation.</li> <li>4. Constant current operation region is within 60% ~ 100% rated output voltage. This is the suitable operation region for LED related applications, but please reconfirm special electrical requirements for some specific system design.</li> <li>5. Derating may be needed under low input voltages. Please check the static characteristics for more details.</li> <li>6. Suitable for indoor use or outdoor use without direct sunlight exposure. Please avoid immerse in the water over 30 minutes.</li> <li>7. Length of set up time is measured at cold first start. Turning ON/OFF the power supply may lead to increase of the set up time.</li> <li>8. The power supply is considered as a component that will be operated in combination with final equipment. Since EMC performance will be affected by the complete installation, the final equipment manufacturers must re-qualify EMC Directive on the complete installation again.</li> </ol>										

**Mechanical Specification**

Case No. LPF-60B Unit:mm

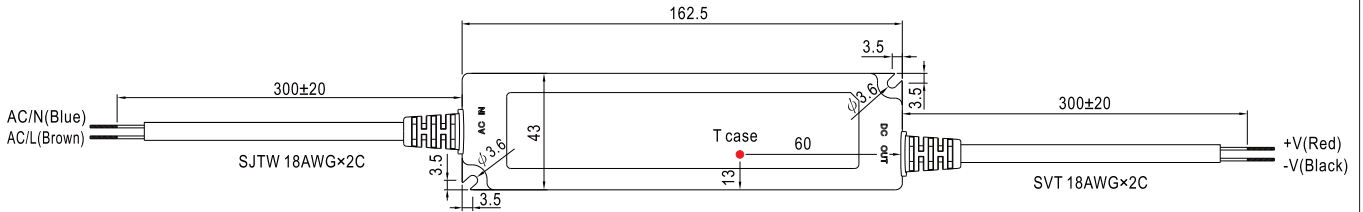

※ T case: Max. Case Temperature.



**Recommend Mounting Direction**

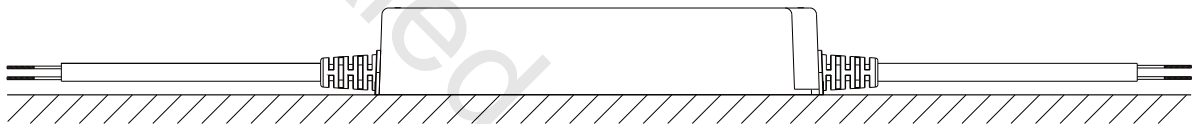

**Block Diagram**

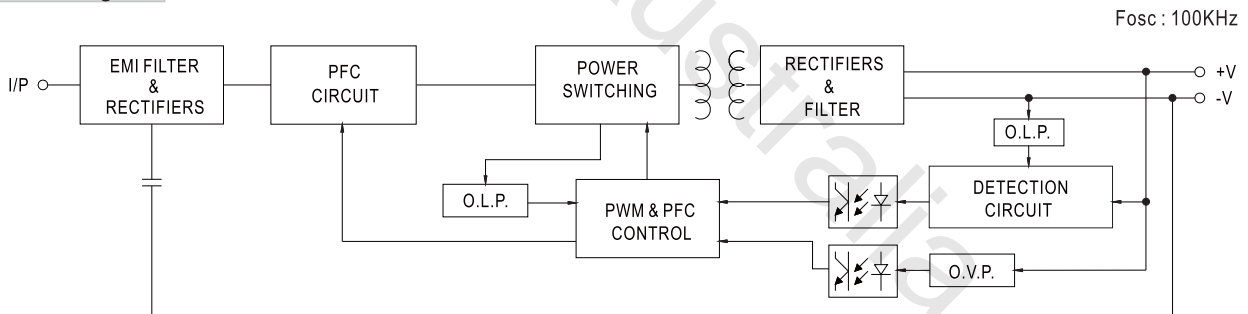

**Derating Curve**

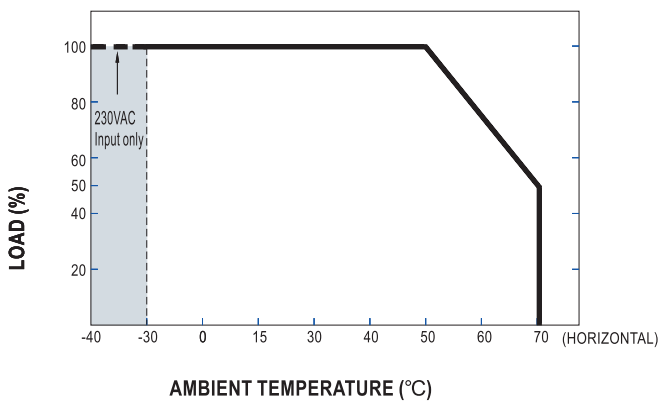

**Static Characteristics**

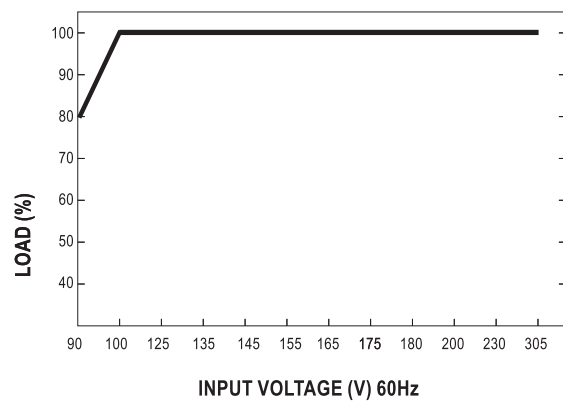

**Power Factor Characteristic**

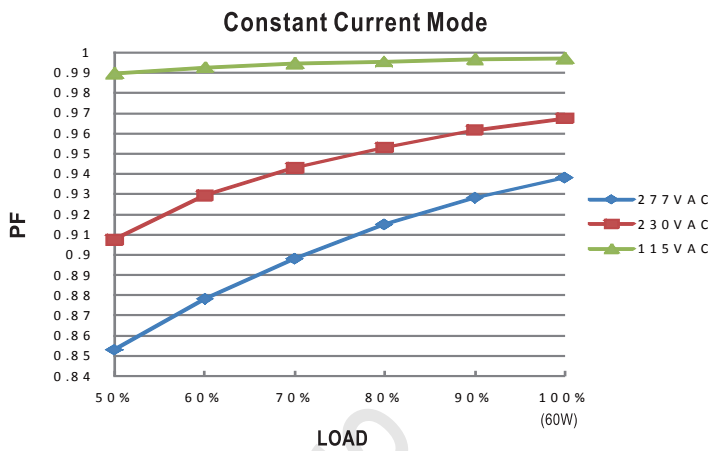

**EFFICIENCY vs LOAD (48V Model)**

LPF-60 series possess superior working efficiency that up to 90% can be reached in field applications.

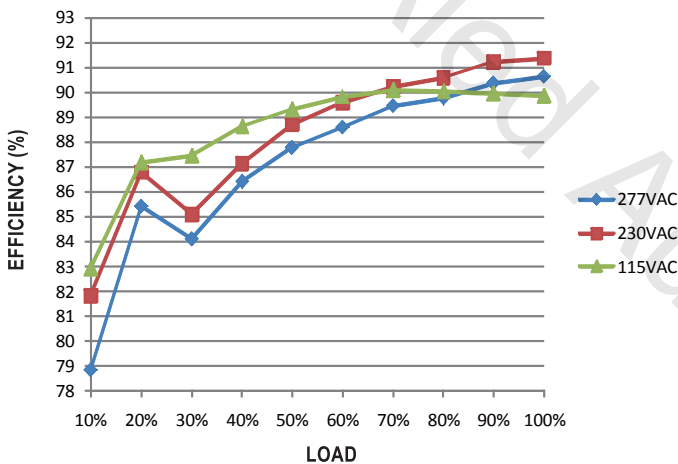

**DRIVING METHODS OF LED MODULE**

There are two major kinds of LED drive method "direct drive" and "with LED driver".

A typical LED power supply may either work in "constant voltage mode (CV) or constant current mode (CC)" to drive the LEDs.

Mean Well's LED power supply with CV+ CC characteristic can be operated at both CV mode (with LED driver, at area (A) and CC mode (direct drive, at area (B)).

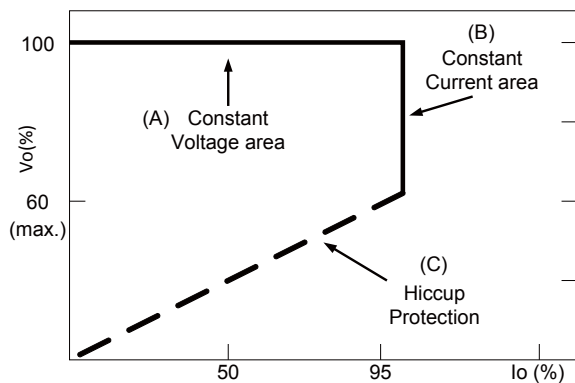

Typical LED power supply I-V curve